

# Turnstyle Designs Ltd – Pocket Door Hardware

**REVOLVING RING FLUSH HANDLES ~ S1952 ## 1001**

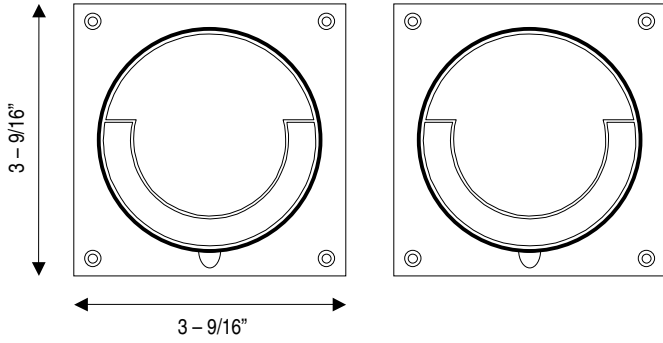

**LEADING EDGE FLUSH PULL ~ S1407 ##**

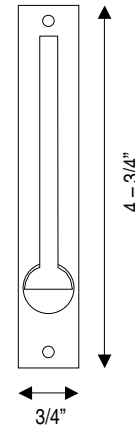

**FLUSH LATCH HANDLE ~ S1953 ## 1001**

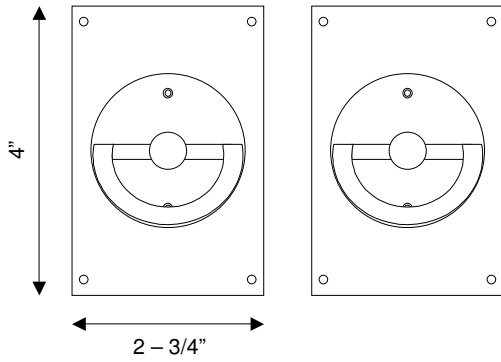

**PLAIN FLUSH PULL ~ S1405 ## 1001**

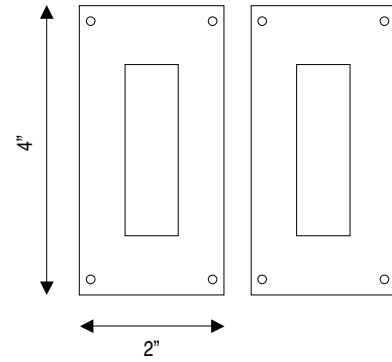

**ROUND FLUSH LATCH HANDLE ~ S1954 ## 1001**

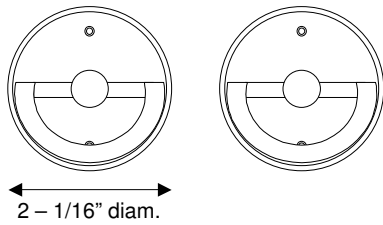

**KIDNEY FLUSH PULL ~ S1406 ## 1001**

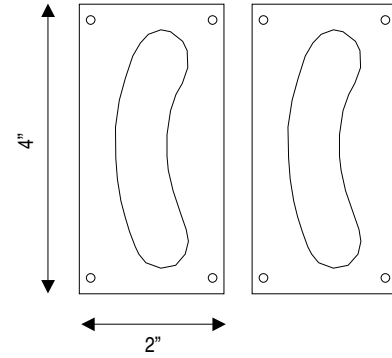

**MORTICE HOOK BOLT ~ K1951 ## 1785**

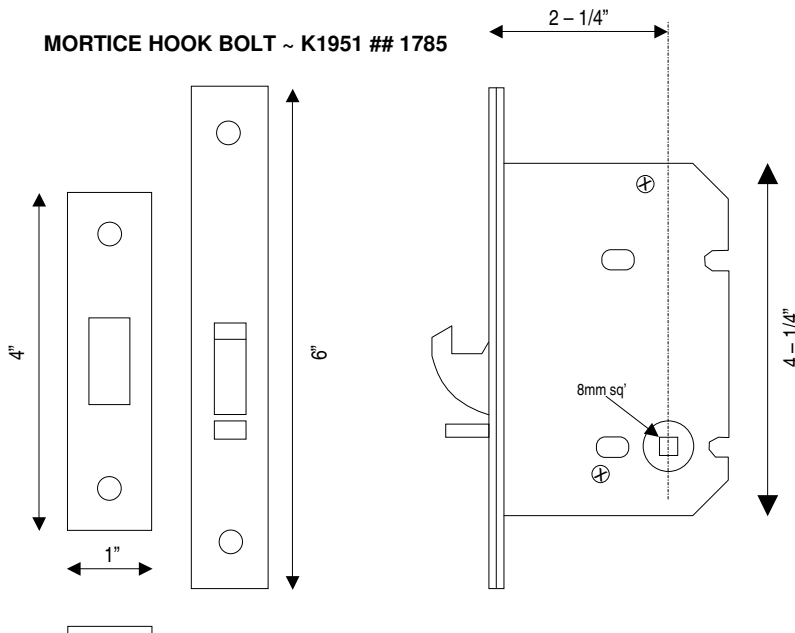

Bolt thrown by turn from either side.

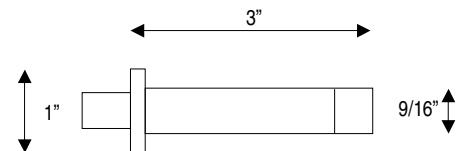

**FINISHES**

- Bright Chrome / Satin Nickel
- Dark Bronze / Polished Nickel

Custom finishes available to order.



# POCKET DOOR LOCK / PULL ~ 31166

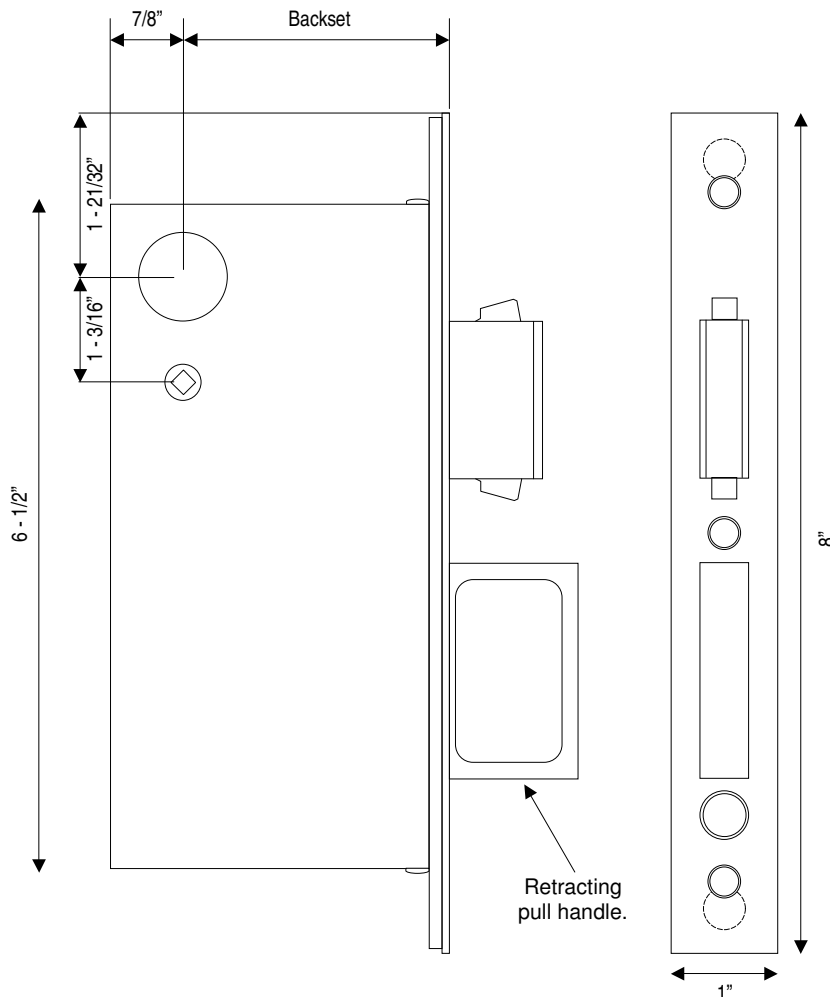

Bolt thrown by turn or key from either side.

Push button projects pull.

## Please specify

2-1/2, 2-3/3, 3-3/4, 5 or 6 inch backset

Case : 11/16" thick

Dead bolt : 1/2" thick, 1-7/32" high, 1" throw

Pull : 1/2" thick, 2" high, 1-1/4" throw

Thumb turn hub : 3/16" on the diamond

## FINISHES

Bright Chrome / Satin Nickel

Dark Bronze / Polished Nickel

Custom finishes available to order.



# POCKET DOOR STRIKE / PULL ~ 31167

For use in double door applications, opposing the pocket door lock / pull (31166).

Push button projects pull.

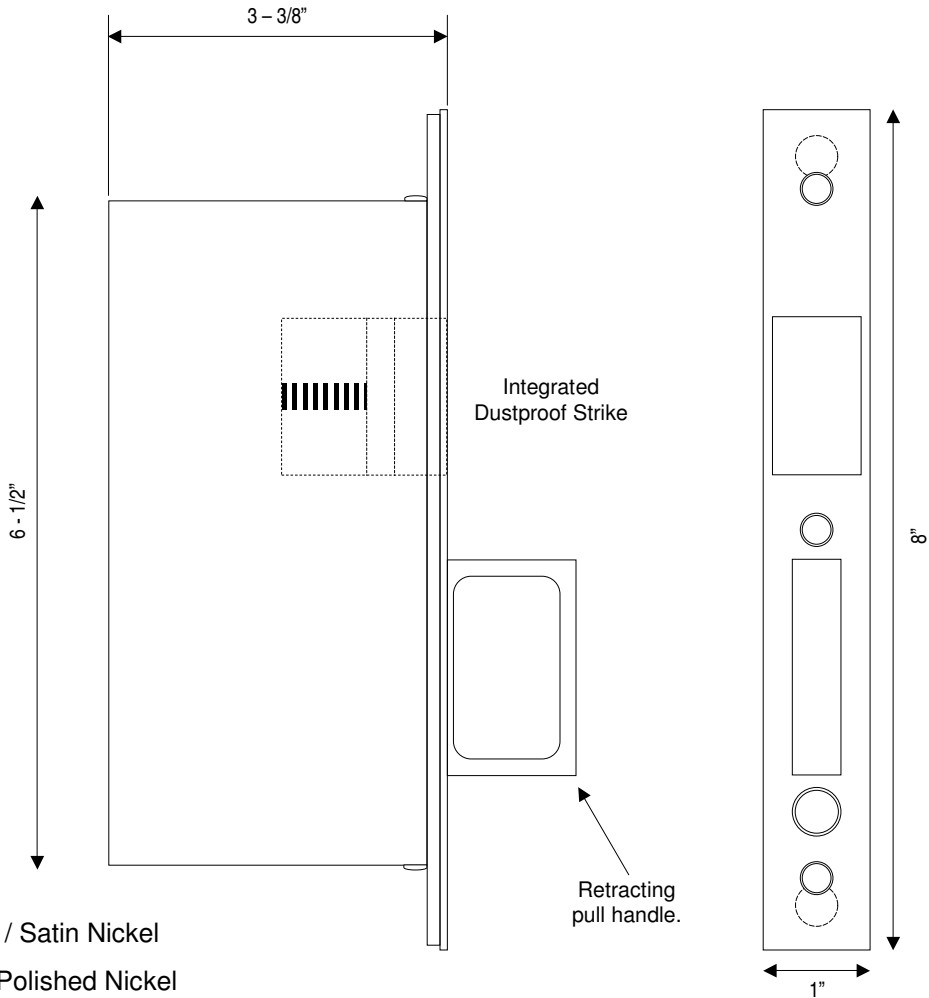
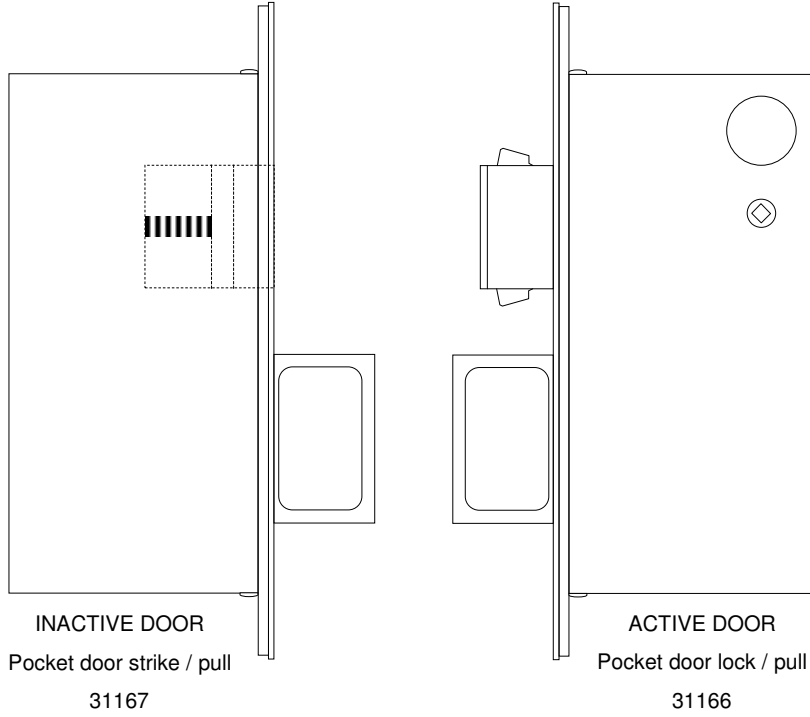

## FINISHES

Bright Chrome / Satin Nickel

Dark Bronze / Polished Nickel

Custom finishes available to order.



# POCKET DOOR PULL ~ 31168



**Case : 11/16" thick**

**Pull : 1/2" thick, 2" high, 1-1/4" throw**

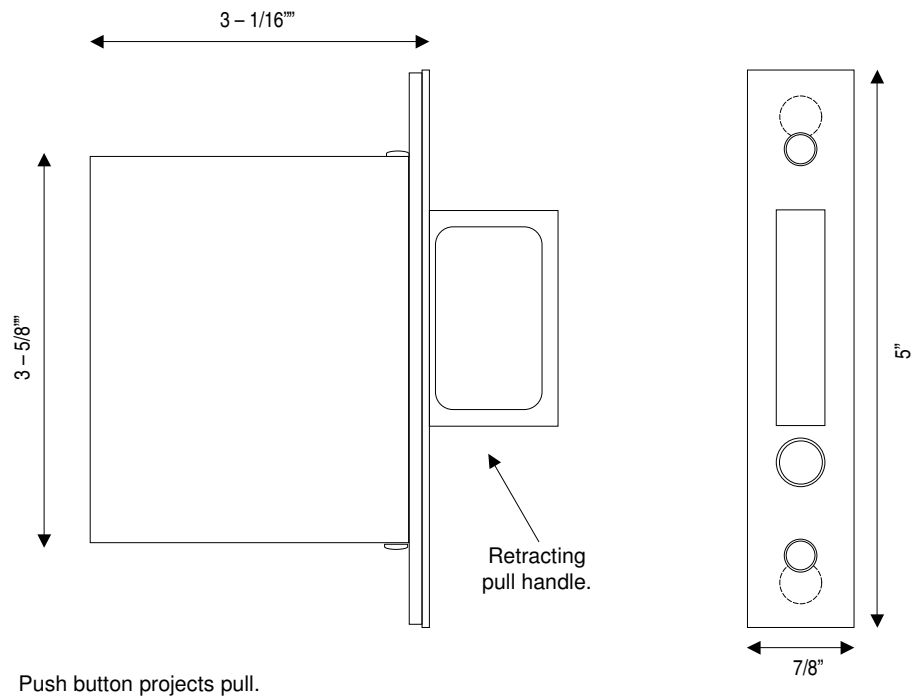

Push button projects pull.

## FINISHES

Bright Chrome / Satin Nickel

Dark Bronze / Polished Nickel

Custom finishes available to order.



# FLUSH PULLS FOR USE WITH POCKET DOOR LOCK / PULL

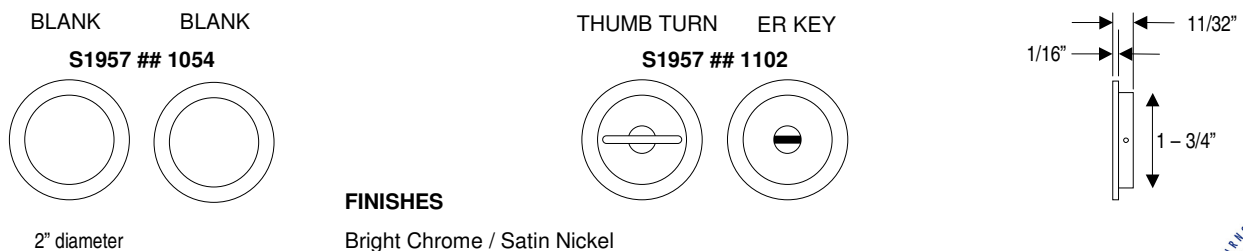
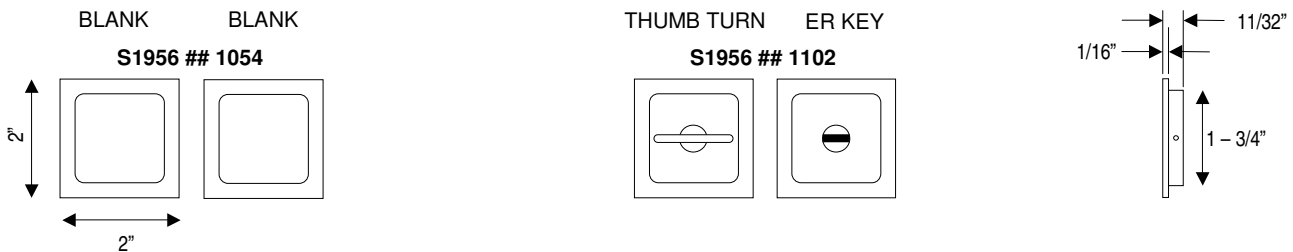
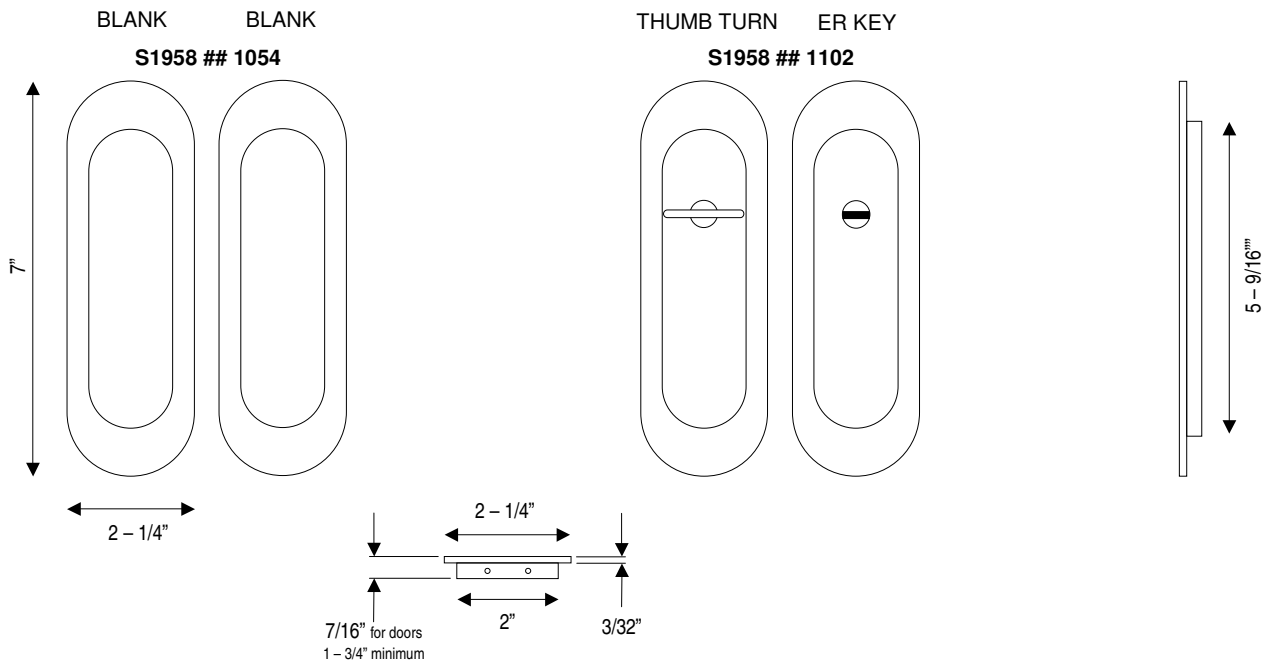
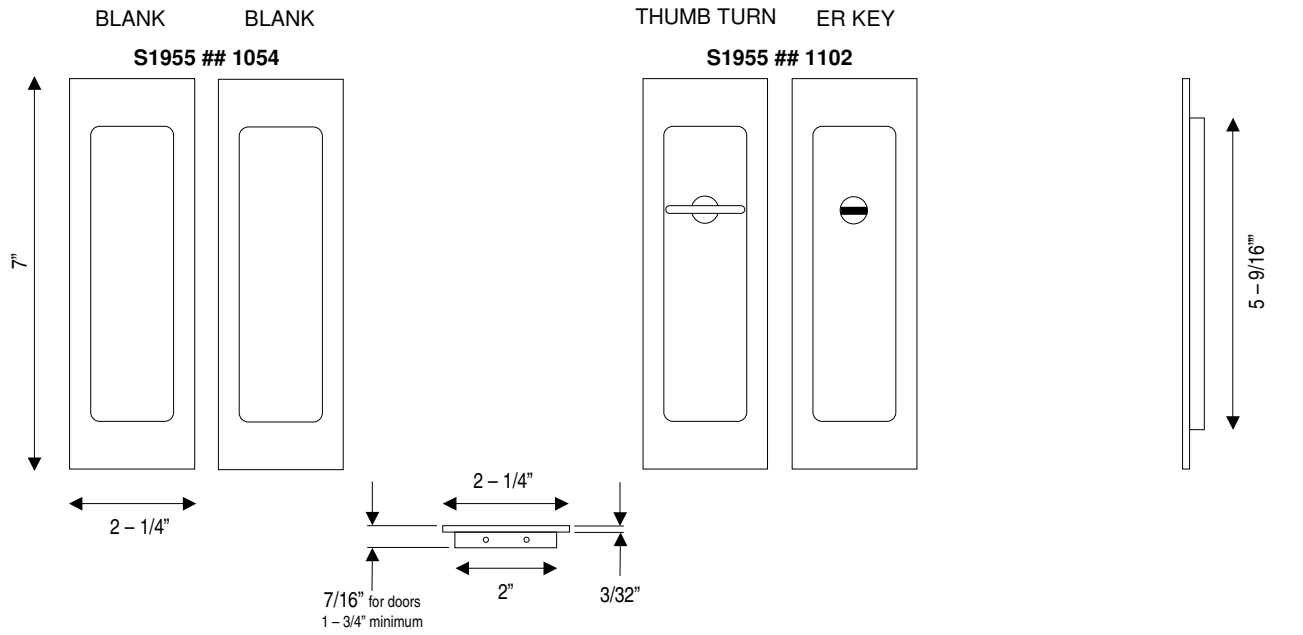

## FINISHES

Bright Chrome / Satin Nickel  
Dark Bronze / Polished Nickel  
Custom finishes available to order.

