

LOCKS AND LATCHES

Please note that with all external doors and windows we advise you check with your insurance company what their requirements are to ensure you are fully covered in the event of a break in. Turnstyle Designs does not accept any liability in the event of break ins.

It should be noted that any lock or latch is only as strong as the door and frame to which it is fitted.

Full lock specification sheets are available upon request.

Choosing the correct latch

In the UK there are three types of latches typically used within domestic settings.

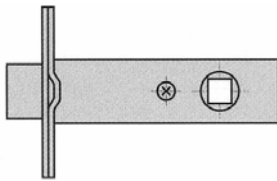

1. Tubular mortice latch (page 54) – Easy to fit, most commonly used as an independent latch. Suitable for use with door knobs as has a two-way action. Available in a number of sizes.

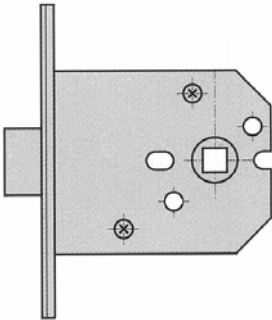

2. Mortice latch (page 54) also known as a box type latch – A more substantial device. More skill required to fit if fitting from new. Has a one way action so not suitable for use with knob furniture.
3. Rim latch – Face fitted (not morticed into the door) normally used on thinner doors or ledged and braced doors which cannot be morticed. Please call for details.

Points to consider

Turnstyle Designs only stock quality British made locks and latches from long established, trusted manufacturers. At the end of the day the performance of the door handle is wholly dependent on the latch or lock. If in any doubt about the age or quality of your existing latch or lock we recommend, that for peace of mind, you change them at the same time as the handle.

A Grade - The majority of our locks and latches are available in a premium 'A' grade format. These products are supplied with a box strike plate or dust box to improve security and to conceal the mortice in the door frame.

Note - If fitting door knob furniture we advise you use a minimum backset of 75mm to avoid scraping knuckles on the door frame.

Choosing the correct lock

BS3621 - British Standard covering lock security. The level of security strongly recommended by the police and many insurance companies. The standard includes many security features, ensuring the lock is resistant to attack by drill, saw or force.

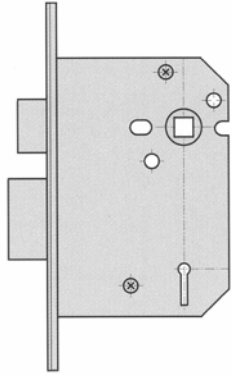

1. Five lever mortice locks (page 54) – Key operated from either side of the door. We recommend fitting the British Standard lock to external doors. Available in both sashlock and deadlock styles. For ease of use we recommend 72mm centre sashlocks.

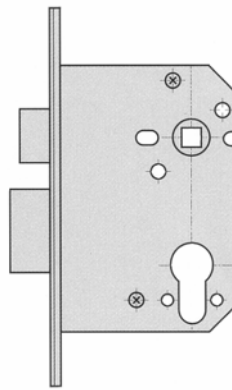

2. Euro profile cylinder locks (page 54) – Can be key operated from either side (double cylinder), key operated from one side only (single cylinder) or key operated from one side and turn operated from the other (key/knob cylinder). British Standard euro profile locks are supplied with a double cylinder (71mm long) and security escutcheons. For all non British Standard euro profile locks please order cylinders separately. Available in both sashlock and deadlock styles. For ease of use we recommend 72mm centre sashlocks.

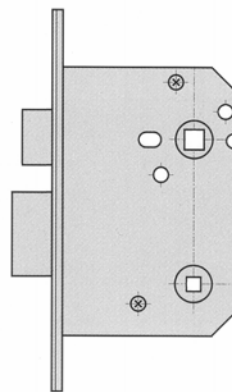

3. Bathroom mortice lock (page 55) – A combination of latch and deadbolt. Latchbolt is operated by the door levers / knobs. Deadbolt is operated by snib / thumbturn from inside the bathroom. If using door knobs we recommend using the 72mm centre bathroom lock to provide adequate clearance, alternatively use a combination of tubular latch and tubular bolt.

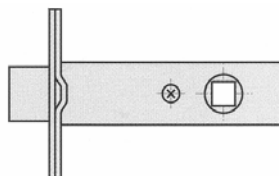

4. Mortice tubular bolt (page 55) – Operated by a snib / thumbturn from inside the bathroom. Easy to fit and generally used in conjunction with a tubular latch.

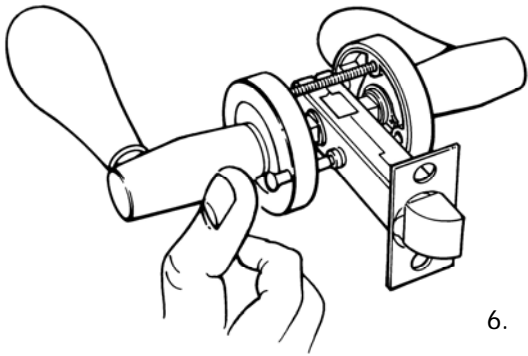

5. Privacy latch – A clever variation of the tubular latch that locks when a privacy pin (on rose) is pushed in. The lock releases when the internal door lever is depressed, it can also be released from the outside in emergencies. A discreet system that is easy to install. See pages 5, 6, 7, 9 and 10 of brochure for design options. Privacy latches have a 60mm backset.
6. Mortice security bolt (page 55) – operated by a universal ‘star’ key. Provides extra security for doors and windows.

Points to consider

Turnstyle Designs only stock quality British made locks and latches from long established, trusted manufacturers. At the end of the day the performance of the door handle is wholly dependent on the latch or lock. If in any doubt about the age or quality of your existing latch or lock we recommend, that for peace of mind, you change them at the same time as the handle.

A Grade - The majority of our locks and latches are available in a premium ‘A’ grade format. These products are supplied with a box strike plate or dust box to improve security and to conceal the mortice in the door frame.

If fitting door knob furniture we advise you use a minimum backset of 75mm to avoid scraping knuckles on the door frame.

Escutcheons - are available to protect the door surface around your key hole. The relevant style of escutcheon is shown with each group of door levers or knobs. Slotted escutcheons are used with 5 lever locks and euro profile escutcheons are used with cylinder locks.

If ordering Euro profile locks please state door thickness. As various length cylinders are available. If not quoted cylinders will be supplied at a length of 71mm.

Keyed alike – For convenience it is sometimes necessary for a number of locks to be operated by the same key. Please let us know when ordering if this facility is required. Please note BS3621 locks cannot be keyed alike with any other locks.

Master keyed – When ordering your locks please note that, as a matter of convenience it is sometimes a requirement that a number of locks, which all differ, in addition to being operated by their own key (servant keys) also operate by an overriding key known as a master key. These sets can also be subdivided and are all made to order. Please contact us for further advice when ordering.

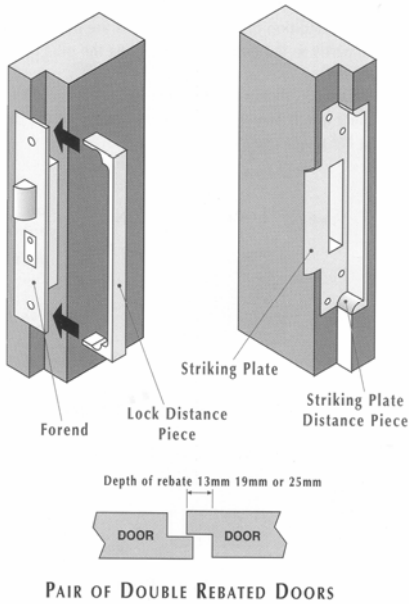

Rebate sets - Pairs of doors often have rebated meeting stiles with 13mm or 25mm rebates (see diagram). Mortice locks and latches fitted to these doors need rebate kits of the correct size to convert the forend to suit.

When ordering locks and latches please be sure to specify the following:

- Type of lock, i.e euro profile deadlock
- Backset, i.e. 45mm
- Door thickness (if ordering euro profile)
- Finish of strike and face plate, i.e. bright chrome
- Product code

And don't forget:

- Escutcheons
- Cylinders
- Keyed alike or master keyed

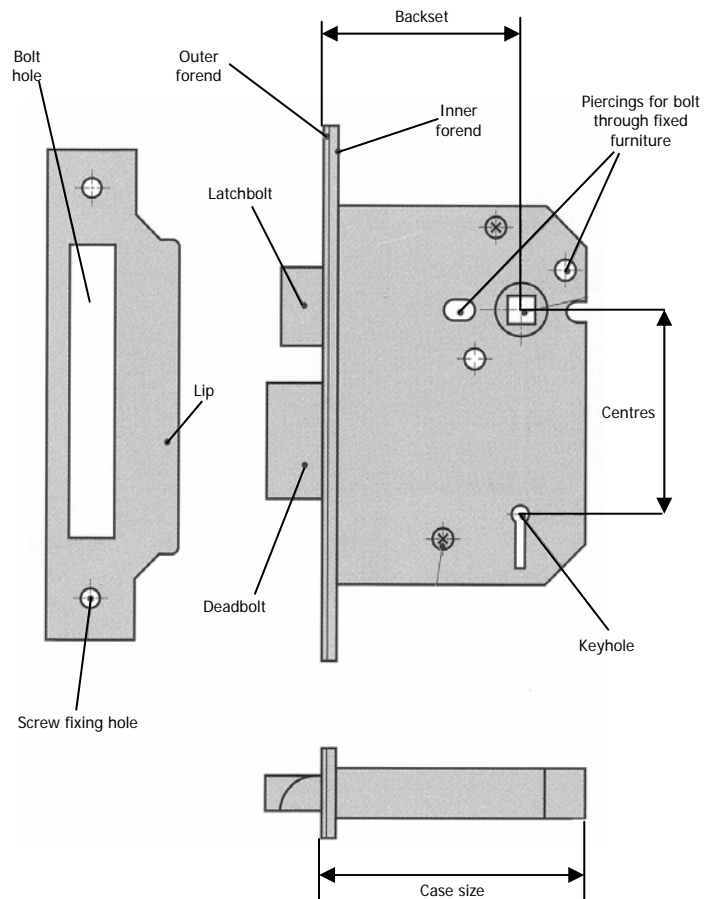

Many other styles of locks are available, please contact us for details.